

CABLEADO CON BORNAS. TELÉGRAFO ELÉCTRICO DE DOS HILOS.

ESQUEMA ELÉCTRICO

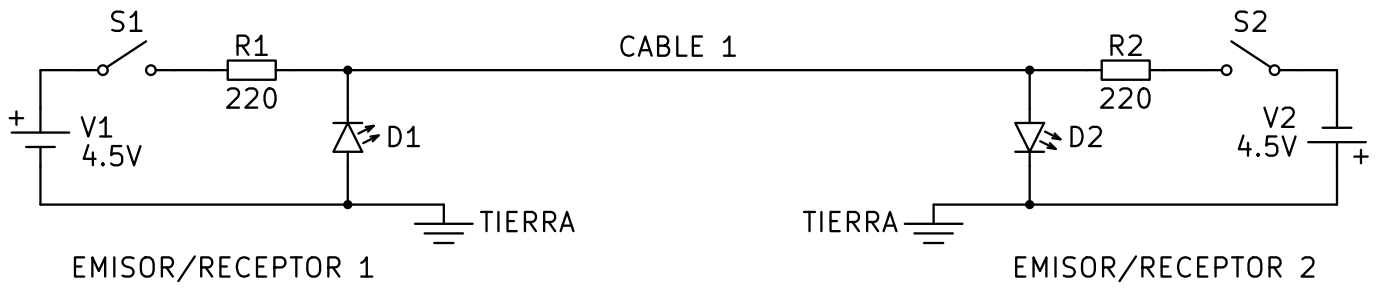

LISTADO DE COMPONENTES

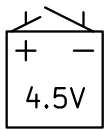

2 x PILA DE PETACA

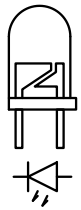

2 x LED BLANCO DE ALTA LUMINOSIDAD



2 x RESISTENCIA DE 220 OHMIOS ROJO, ROJO, MARRÓN, ORO



2 METROS DE CABLE FLEXIBLE

2 x PULSADOR DE TELÉGRAFO

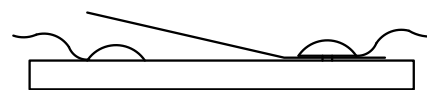
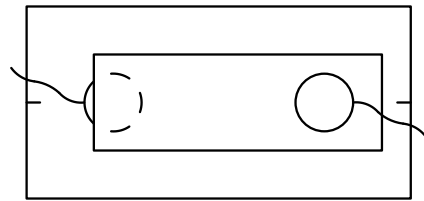

2 x 6 BORNAS DE CONEXIÓN

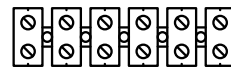

CABLEADO DEL CIRCUITO

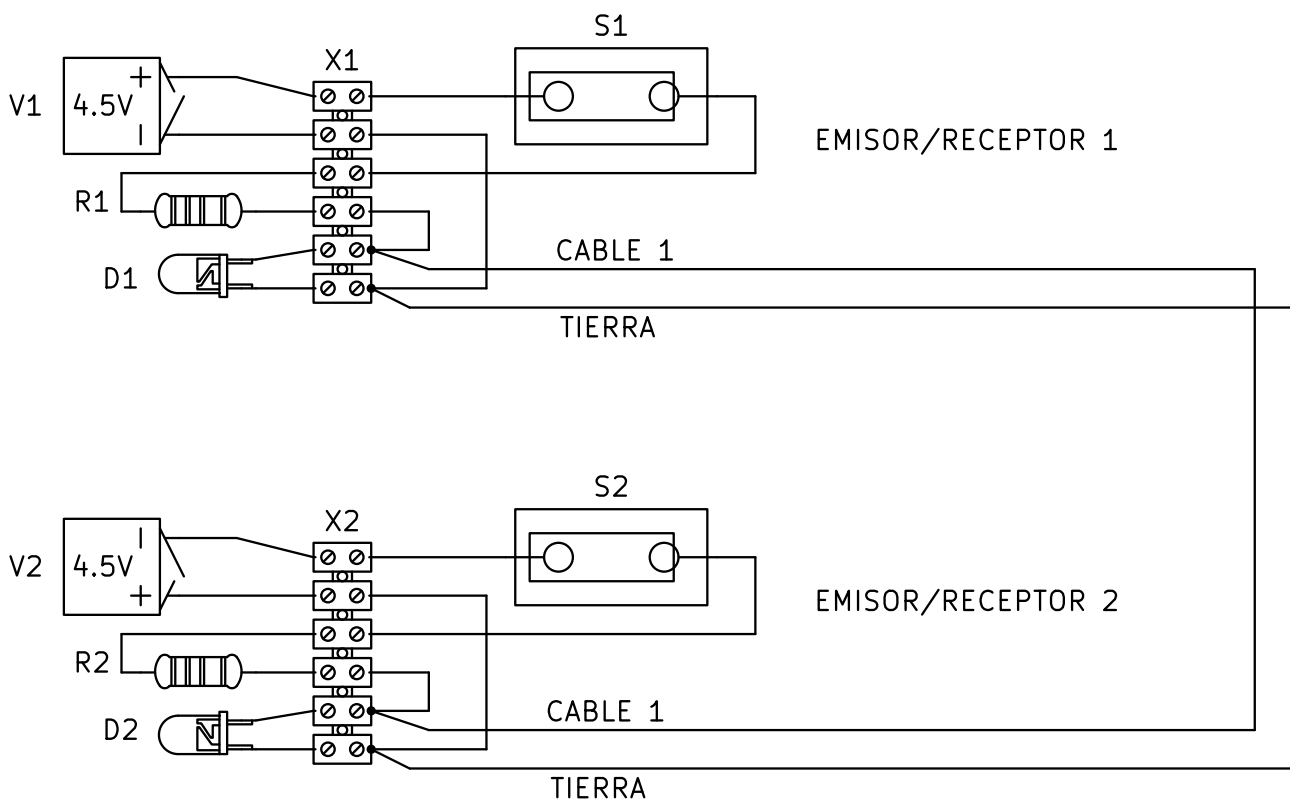

CABLEADO CON BORNAS. TELÉGRAFO ELÉCTRICO DE DOS HILOS.

ESQUEMA ELÉCTRICO

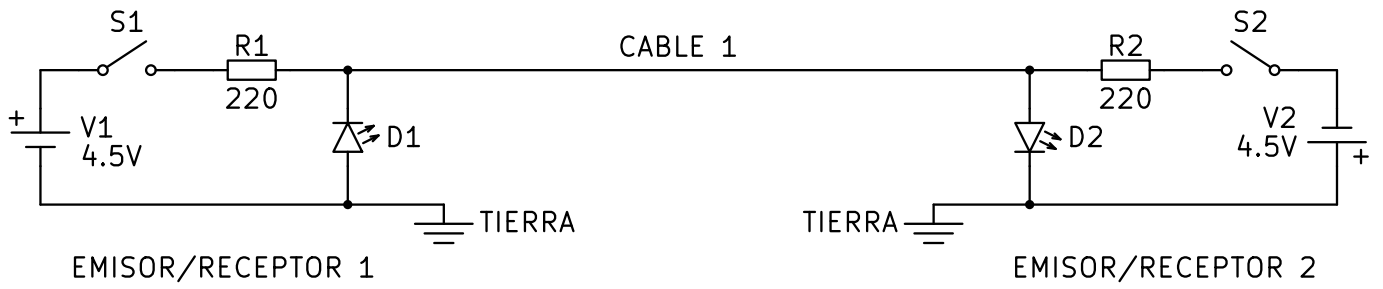

LISTADO DE COMPONENTES

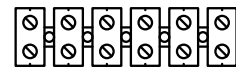
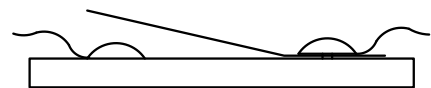
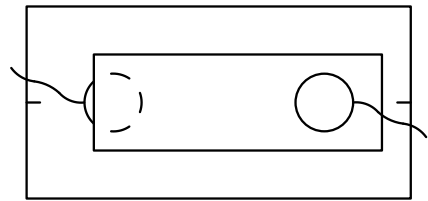
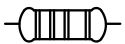
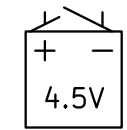

CABLEADO DEL CIRCUITO

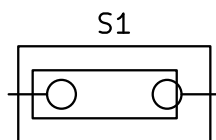
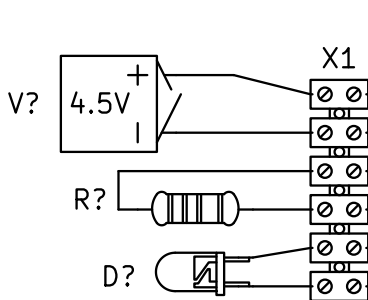

EMISOR/RECEPTOR 1

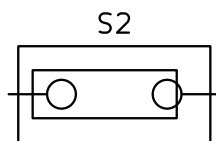
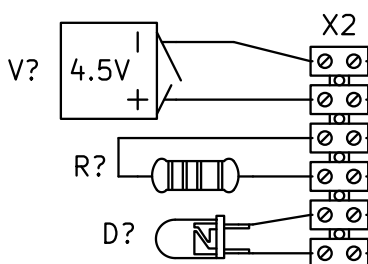

EMISOR/RECEPTOR 2