

CABLEADO CON BORNAS. CARGA Y DESCARGA DE UN CONDENSADOR

ESQUEMA ELÉCTRICO

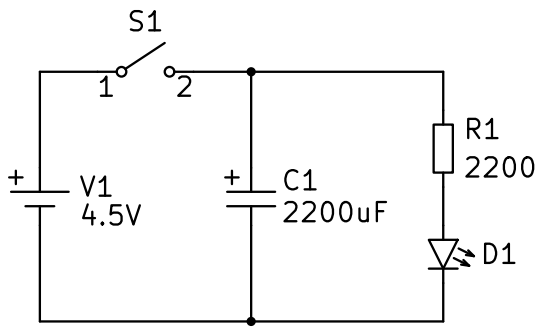

CARGA Y DESCARGA DE UN CONDENSADOR

LISTADO DE COMPONENTES

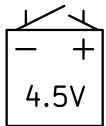

1 x PILA DE PETACA

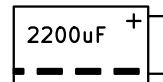

1 x CONDENSADOR 2200µF



1 x RESISTENCIA 2200
ROJO, ROJO, ROJO, ORO



1 x LED BLANCO 5MM
ALTA LUMINOSIDAD

CABLEADO DEL CIRCUITO

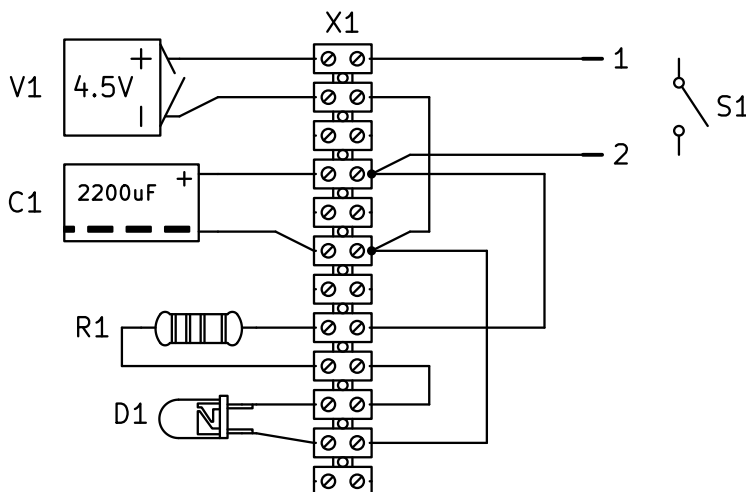

CABLEADO CON BORNAS. CARGA Y DESCARGA DE UN CONDENSADOR

ESQUEMA ELÉCTRICO

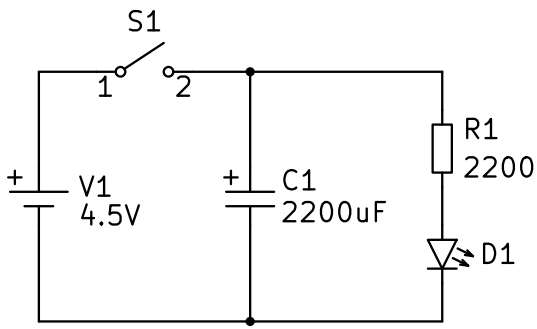

CARGA Y DESCARGA DE UN CONDENSADOR

LISTADO DE COMPONENTES

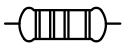
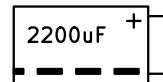
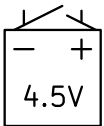

CABLEADO DEL CIRCUITO

